

Slough Local Development Framework

Residential Extensions Guidelines
Supplementary Planning Document

Adopted January 2010

Slough Local Development Framework

Residential Extensions Guidelines Supplementary Planning Document Adopted January 2010

Planning Policy and Projects
Slough Borough Council
Town Hall
51 Bath Road
Slough
SL1 3UF
Tel: 01753 477341/875820/875863
Email: planningpolicy@slough.gov.uk
Printed November 2009

Contents

	Glossary of terms.....	4
1.0	Introduction	5
1.1	Background and policy context	5
1.2	The role of the Residential Extensions Guidelines Supplementary Planning Document	5
1.3	The need for planning permission	6
1.4	What other permissions are required?	6
1.5	What you should include in your application	7
1.6	The planning process	8
2.0	Design principles	9
2.1	Design considerations	9
2.2	Amenity considerations.....	9
3.0	Front extensions	11
4.0	Single storey side extensions	13
5.0	Two storey/first floor side extensions.....	15
6.0	Single storey rear extensions	20
7.0	Two storey/first floor rear extensions.....	22
8.0	Roof extensions/dormer windows/roof lights	24
9.0	Outbuildings	26
10.0	Garages, parking and hard surfacing	27
11.0	Garden space/boundary walls	29
	Appendix 1 - Core Strategy Planning Policies and extract of Saved Local Plan Policies	31
	Useful telephone numbers	37

Glossary of terms

Agent

A specialist acting on your behalf in the design of the works to your house and the preparation of your application. The agent is usually an architect or building surveyor.

BRE daylight/sunlight guidance

British Research Establishment sets out guidance for assessing the impact of new development on daylight/sunlight into existing windows.

Character

The combination of features of a building or an area that give it its distinctive identity compared with other buildings or areas.

Established building line

An identifiable line formed by the regular alignment of houses within an existing street frontage.

Flank wall elevation

The side wall of an existing dwelling or proposed extension.

Flood Risk Assessment

Flood Risk Assessments are normally required for houses for which domestic extensions are proposed, which fall within Flood Zones 2 and 3, the details for which can be found on the Environment agency's Web site. A Flood Risk Assessment for such developments is usually quite simple and may need to include proposals to reduce flood risk such as raising finished floor levels or measures for flood-proofing.

Gable

The triangular upper portion of a wall at the end of a pitched roof.

Habitable room

Includes rooms such as living rooms, dining rooms, bedrooms kitchen-diners and studies. Does not include hall ways or bathrooms or separate kitchens.

Hipped roof

A roof sloping (pitched) in two directions; side as well as front and back.

Permitted development

Some domestic extensions, garages, sheds, installations and boundary treatments benefit from 'permitted development'. In other words an application for planning permission will not be required as they are already types of development which benefit from permission.

Pitched roof

A sloping roof, usually at an angle between 30 and 50 degrees.

Ridge

The horizontal top edge of the roof.

Roof light

A window set within the slope of a roof (sometimes known as a 'Velux' window).

Secure by design

Looking at designing buildings and spaces so as to reduce the potential for criminal activity and anti-social behaviour.

Streetscene

The character of the street or road in which the building is located.

Subservient/Subordinate

The effect of an extension on the original building i.e. the extension should not dominate the original.

Symmetrical

When the design of the building is identical either side of the centreline of a building.

Visual terracing effect

Developments, usually two storey/first floor side extensions which result in the closure of the gap/loss of airspace at first floor level between existing houses

Visual gap

The air space which exists at first floor level between existing houses.

1.0 Introduction

1.1 Background and Policy Context

1.1.1 The Residential Extensions Guidelines Supplementary Planning Document (SPD) replaces the previous Development Control Guidelines for Residential Extensions approved by the Council in February 1994. The previous guidelines proved to be of significant benefit in achieving satisfactory schemes and were generally accepted by householders. The Residential Extensions Guidelines SPD has been produced in the light of increasing pressures for householders to build larger and more dominant extensions. These extensions are impacting on both the general street scene and on residential amenities within established residential areas of Slough.

1.2 The Role of the Residential Extensions Guidelines Supplementary Planning Document (RESPD)

1.2.1 The Residential Extensions Guidelines Supplementary Planning Document (RESPD) is one of a number of supplementary planning documents being produced by Slough Borough Council. The purpose of this document is to principally provide additional guidance on how to interpret and implement Core Policy 8 (Sustainability and the Environment) of the Slough Local Development Framework Core Strategy 2006 - 2026 (adopted 2008) when assessing extensions to residential properties.

1.2.2 Core Policy 8 (Sustainability and the Environment) states:

"All development in the Borough shall be sustainable, of a high quality design, improve the quality of the environment and address the impact of climate change... All development will:

a) Be of a high quality design that is practical, attractive, safe, accessible and adaptable;

b) Respect its location and surroundings;

c) Provide appropriate public space, amenity space and landscaping as an integral part of the design; and

d) Be in accordance with the Spatial Strategy in terms of its height, scale, massing and architectural style.

The design of all development within the existing residential areas should respect the amenities of adjoining occupiers and reflect the street scene and the local distinctiveness of the area."

1.2.3 Additionally the RESPD may also be used to support the implementation of Saved Policies H14, H15, EN1, EN2 and T2 of the Slough Local Plan (2004), until such time as they are replaced by policies in other Development Plan Documents. Planning policies are contained within Appendix 1.

1.2.4 Extensions can have positive and negative effects on your property and the surrounding area and residents. For example, large extensions can result in overshadowing of neighbouring properties, result in loss of daylight and outlook for neighbours and be visually intrusive. Such extensions may also look out of character with the original dwelling and adversely affect the overall appearance of a dwelling house within the street scene and surrounding area.

1.2.5 As such, the guidance seeks to set out the basic design principles and amenity considerations and more detailed guidance on specific types of extensions with a view to ensuring that:

- extensions complement the original property, and
- any impact on the amenity of neighbouring residents and the character of the locality is acceptable.

1.2.6 Ultimately the aim is to ensure that the residential areas within Slough remain good places to live and are not adversely affected by inappropriate extensions.

- 1.2.7 Please note: This document shows examples of good practice and what is considered acceptable for extensions and additions in this borough. Whilst this guide provides the overall framework, it is not possible to foresee all the circumstances which might arise for any particular building and each planning application will be judged on its own individual merits. The drawings inserted in this document are to be used for illustrative purposes only.
- 1.3 The Need for Planning Permission**
- 1.3.1 If you live in a single family dwelling house you may have 'permitted development rights' that allow you to erect small extensions or garden sheds without planning permission. However if you live in a designated Conservation Area, a flat or a listed building these permitted development rights may not apply.
- 1.3.2 On 1 October 2008 the government changed the Permitted Development Rights for dwelling houses. The new regulations have introduced changes to the former provisions to make it easier to carry out some extensions under permitted development. For example the old volume restrictions for extensions to properties no longer apply. However, some proposals which were previously "permitted development" will now require planning permission, such as rear extensions over 3m in depth. One major change is that new or replacement paving or surfacing of a front garden will now require permission where it is more than five square metres; where it is not porous; or where run-off cannot be channelled to a porous area in the site boundaries (such as a garden border). New conditions have also been added, which need to be complied with. There are also changes to the rules regarding roof alterations and outbuildings. New controls have also been introduced for chimneys, flues, soil and vent pipes, balconies, verandas, decking, solar panels and other domestic micro-generation equipment.
- 1.3.3 The changes, whilst they have brought in some relaxations, still involve a complex set of criteria and conditions. It is therefore strongly recommended that you seek advice from the Council's Planning Department before proceeding. You also need to be aware that in some cases permitted development rights may have been removed as part of previous planning permissions. It is therefore important to check with the Planning Department to establish whether permitted development rights for your property have been removed or varied before you start any work.
- 1.3.4 Further information on the changes can be found at the Planning Portal website <http://www.planningportal.gov.uk/> [go to 'General Public', 'Building Work', 'Common Projects', 'Extensions', etc.]
- 1.3.5 You can also download the full regulations: "The Town and Country Planning (General Permitted Development) (Amendment) (No. 2) (England) Order 2008" from the Office of Public Sector Information (Statutory Instrument 2362) at: http://www.England-legislation.hmso.gov.uk/si/si2008/pdf/ukSI_20082362_en.pdf
- 1.3.6 If you wish to gain a formal opinion about whether or not planning permission is required you will need to make an application for a Certificate of Lawful Development.
- 1.4 What Other Permissions are required?**
- 1.4.1 If you live in a designated Conservation Area you will need to apply for planning permission for certain types of work which do not need an application in other areas. If your proposal affects a listed building it will be necessary to obtain Listed Building Consent before undertaking any work. The character and appearance of the building and/ or conservation area must be preserved or enhanced. The design and detailing of the proposals will be particularly important in these cases.

- 1.4.2 If your house is situated in a designated Residential Area of Exceptional Character, more stringent design criteria may apply. Refer to Policy H12 of the Adopted Local Plan for Slough, 2004.
- 1.4.3 If your property adjoins the Grand Union Canal you are advised to discuss your proposals with British Waterways to ensure that your proposals do not in any way interfere with the structural integrity of the canal wall.
- 1.4.4 Please note: Even though planning permission may not be required for certain house extensions, this does not remove the requirement to make an application under the Building Regulations (this deals with health and safety and structural aspects of the building).
- 1.4.5 If you are in any doubt, call the Planning Department or Building Control Section of Council. Useful telephone numbers are given at the end of this document.
- 1.5 What you should include in your application**
- 1.5.1 When submitting your application, make sure you have completed the appropriate application form, supplied the required information and correct application fee.
- 1.5.2 The following drawings will need to be submitted with the application:
- Ordnance Survey or Location plan (at scale 1:1250) with the application site outlined in red (NB: any adjoining land also owned by the applicant but not forming part of the application site should be outlined in blue) and the direction of north indicated on the plan
 - Site layout plan (1:500 or 1:200) showing the proposed development in relation to the site boundaries and any other relevant features of the site or adjoining land - i.e. access arrangements, parking layout, trees, boundary treatment, changes in ground level, etc
 - Existing and proposed elevations and floor plans (1:100 or 1:50)
- Existing and proposed site sections and finished floor levels (1:100 or 1:50)
 - Existing and proposed roof plans (1:100 or 1:50)
- 1.5.3 Please ensure all drawings and plans submitted with the application are titled and numbered for identification purposes.
- 1.5.4 You will need to submit four copies of the completed application form (including the original) and six copies of the full set of drawings, unless you are submitting the application electronically. Notwithstanding this, copies may still be required.
- 1.5.5 A complete checklist of the information required to be submitted is available from the Planning Department.
- 1.5.6 Employing a suitably qualified agent to prepare your plans may help you achieve a design that meets both your needs and the Council's policies. This is recommended. A pre-application meeting with Planning Officers to discuss your ideas and proposals can help to reduce changes to your scheme later on.
- 1.5.7 When preparing your application you will need establish whether or not your house falls within a flood risk zone. If it falls within either flood zone 2 or 3 then your application will need to be accompanied by a flood risk assessment. You may need to give consideration either to raising finished floor levels or include floodproofing as part of your proposal. Refer to the Environment's Standing Advice, which can be found by <http://www.environment-agency.gov.uk/static/documents/Research/FRAGuidanceNote2.pdf>
- 1.5.8 If the proposed extension to your house or any associated works encroaches within 8 metres of a main river or 5 metres of a non river water course you should also refer to the Environment's Standing Advice, which can be found by <http://www.environment-agency.gov.uk/static/documents/Research/FRAGuidanceNote2.pdf>

1.6 The Planning Process

1.6.1 Once a planning application has been submitted, it will be formally registered and allocated to a specific Case Officer. The individual Case Officer will notify neighbouring occupiers, who will have the opportunity to make written comments on the proposal. A decision on the planning application will normally be given within 8 weeks of registration, during which time the Case Officer may contact the applicant or agent if amendments to the application are considered necessary. If an agent has been appointed, all negotiations and correspondence will be directed to them. Therefore, applicants requiring any copies of letters or wishing to discuss matters relating to their planning application should contact the relevant planning officer.

1.6.2 Once a formal decision has been made on a planning application, the applicant or their appointed agent will be notified in writing. This will be in the form of a formal Decision Notice, which will either grant or refuse planning permission. If planning permission is refused, the reasons for such a refusal will be set out. Applicants aggrieved by the decision will normally be eligible to lodge an appeal to the Secretary of State within 6 months from the date of that decision notice. The process for doing so will be set out in the Decision Notice. If planning permission is granted, the decision notice may contain one or more conditions, which must be complied with. Such conditions can cover the need to build in accordance with approved plans, the type of materials to be used, car parking, control on the installation of windows in the flank wall of an approved extension, and so forth.

2.0 Design Principles

2.1 Design Considerations

DP1 *Your extension should be in keeping with the original design of the house and its surroundings*

2.1.1 Poorly designed extensions not only erode the character of the original house, but can also impact upon the character of the surrounding area. Therefore it is important that extensions harmonise with the scale and architectural style of the original building, and the character of the area.

DP2 *The form of the extension will depend on the form or shape of the original building*

2.1.2 In most cases extensions will either be a reflection or a continuation of the original building form.

2.1.3 A reflection is an additional volume subordinate to, and reflecting, the character of the original dwelling. This is seen most clearly in the case of a two-storey side extension where the front wall of the extension has been set back at first floor level and the roofline stepped down. The purpose of this form of extension is to preserve the symmetry and rhythm of the original building by reducing the bulk and avoiding a "terracing effect" in the street scene. This form of extension is appropriate in the case of detached or semi-detached dwellings.

2.1.4 Continuation is a simple extension of the existing building form. That is it follows the existing building lines (front and rear walls), roof form, window positions. Continuation extensions are generally appropriate for terraced houses and some detached houses, where there is no problem of potential "terracing" effect or excessive bulk, and where site considerations allow.

DP3 *Extensions should be designed to be subordinate to and in proportion to the original house*

2.1.5 An extension should have a sense of proportion and balance, both in its own right and in its relationship to the original building and should not dominate the original building. This is achieved by:

- Avoiding bulky or overbearing extensions
- Avoiding splayed or irregular designs
- Setting down ridge heights on 2 storey extensions and setting back two storey side extensions at first floor level, unless continuation (refer above) is appropriate
- Reducing the width of extensions (typically no more than 50 percent the width of the original dwelling, especially in the case of two storey extensions)
- Setting in extensions from the boundary
- Avoiding irregular set-ins to overcome impact problems on neighbouring properties, leading to poor designs
- Extensions should not result in the need to raise the height of the existing roof ridge

DP4 *Windows and doors should respect the original house in terms of alignment, style, size, shape and proportion.*

2.1.6 To ensure that the extension remains in keeping with the main house and to maintain proportionality and balance. Advice on security is available by accessing the following web link:
www.securedbydesign.com

DP5 *Materials should match as closely as possible those of the original house*

2.1.7 Poorly matching materials can detrimentally affect the appearance of the original house and have a detrimental effect on the surrounding locality.

2.2 Amenity Considerations

DP6 *Extensions should not be overbearing on neighbouring properties or result in loss of outlook*

2.2.1 The size and siting of an extension should not lead to an extension which is visually imposing or overbearing for neighbouring properties, including creating a sense of enclosure (that is being boxed in) or a loss of outlook when viewed from habitable room windows.

DP7 *Extensions should not result in significant overshadowing, loss of sunlight or daylight*

2.2.2 The size and siting of an extension should not lead to significant overshadowing of neighbouring properties, unreasonably restrict sunlight or block daylight to your neighbours' habitable room windows, which includes lounges, dining rooms, kitchen-dining rooms and bedrooms.

DP8 *Window positions should avoid direct overlooking of neighbouring properties including gardens*

2.2.3 To maintain a reasonable degree of privacy for the occupants of adjacent dwellings, by avoiding the inclusion of windows in extensions which look directly into habitable rooms of neighbouring dwellings or which cause unreasonable levels of overlooking to gardens.

DP9 *Extensions should not be over dominant nor result in there being an unacceptably low level of amenity space*

2.2.4 Whilst the Council appreciates the demand for larger houses to meet the needs of the larger family, there is a concern that increasingly the size of extensions being sought are out of scale with the original house. Over-development will result if too much of the land within the plot is covered by extensions and other structures and this is not acceptable. There is a need to retain a reasonable level of amenity space and to set extensions away from boundaries to achieve proportionality, to reduce the impact on neighbours and reduce the "terracing effect" in the street.

DP10 *Avoid encroaching onto neighbouring properties*

2.2.5 In general the expectation will be that extensions will be built wholly within the curtilage of the property (the application site). In the event that any encroachment is proposed notice will need to be served on the neighbouring occupier. In any event applicants are required to comply with the Party Wall Act and other civil laws.

3.0 Front Extensions

EX1 *Front extensions shall be single storey and normally restricted to front porches only.*

- 3.1 Some relaxation may be acceptable, usually in the case of large detached individually designed properties which are set back at a distance from the nearest highway or other public vantage point(s).
- 3.2 Front extensions will only be permitted if it is considered that they respect the character of the street scene and the design and appearance of the original house.
- 3.3 Front canopies or extensions which span the entire width of a property or dwelling will not normally be permitted unless such extensions form the predominant character of the street as such extensions are considered overly dominant and out of keeping with the character and appearance of the original house. Refer to figure 1.

Figure 1. Overly dominant front extensions

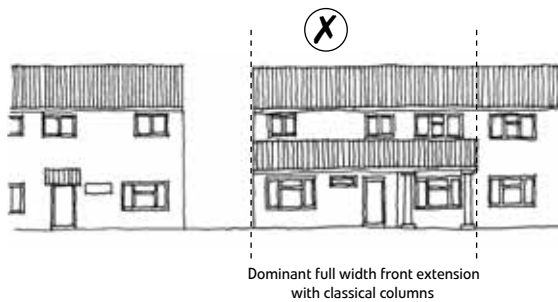

- 3.4 Instead front porch extensions must be in proportion with the original house, must not appear overly dominant in the street scene and must comply with a 45 degree line of sight when measured from the closest habitable room window of neighbouring properties. Refer to figure 2.

Figure 2. Badly and well proportioned front porches

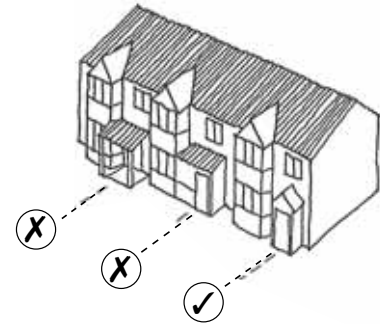

- 3.5 Front extensions should also not adversely affect existing design features on the front elevation of the original house such as bay windows and cornerstone (quoin) detailing. Front extensions should not link into bay windows or project significantly forward of such windows. Where cornerstone detailing exists front extensions should be set clear of these.
- 3.6 Two storey front extensions will not be permitted as it is generally considered that they completely alter the appearance and character of the original house. Such extensions would also tend to be totally out of keeping with the rest of the street. An exception may be made in the case large detached houses set in substantial plots where the dwelling is set back at a significant distance from the road.

EX2 *The following maximum depth for front extensions, as measured externally, shall apply:*

- **Detached houses, 2 metres**
 - **Semi-detached houses, 1.75 metres**
 - **Terraced houses, 1.5 metres**
- 3.7 These guidelines represent the maximum depth allowable for front extensions. A reduction may be required if:
 - the extension would infringe a 45 degree line of sight when measured from the closest habitable room window of the neighbouring property

- the proportions of the front extension are not in keeping with the existing house
- there is insufficient plot depth to accommodate the required level of on site car parking

EX3 *Flat roofs will not normally be permitted*

3.8 Normally, pitched roofs only are acceptable on front extensions and the design and materials should reflect the main roof of the house.

3.9 Flat roofs will only be considered if this better reflects the architectural style of the original house and/or reflects the general character of the existing street scene. The design and materials should reflect the main roof of the house.

EX4 *Doric, fluted or decorative columns will not normally be permitted.*

3.9 Where supporting columns are proposed these should normally be constructed as brick or rendered piers in keeping with the character and appearance of the original house.

4.0 Single Storey Side Extensions

4.1 Where single storey side extensions require planning permission, the following guidance should be taken into account.

4.2 As single storey side extensions are often very visible from the street, it is important to make sure these extensions do not detract from the original dwelling, or from the character of the area as a whole. These extensions should reflect the pattern of development in the street scene.

EX5 *Single storey side extensions should be visually subordinate to the original house.*

4.3 Side extensions should be subordinate to the main house. The appropriate width of a side extension will be judged according to the site circumstances, namely the width of the plot, the width of original dwelling and the site surroundings. Single storey side extensions should not exceed a height of 4 metres.

EX6 *Side extensions should reflect the design of the main house.*

4.4 Single storey side extensions should harmonise with and reflect the architectural form including design features, window detail and materials of the original house.

4.5 The roof of a single storey side extension should be in keeping with the roof of the original dwelling. Where feasible, the design and style together with the appropriate degree of hip and/or pitch should reflect that of the main roof. Refer figure 3 below.

Figure 3. Well proportioned side extensions in keeping with and reflecting the main dwelling

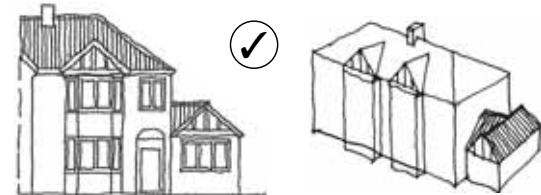
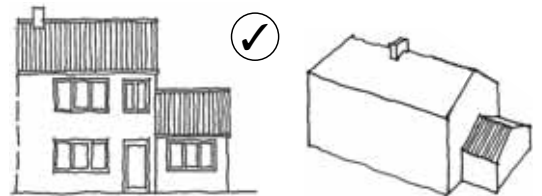
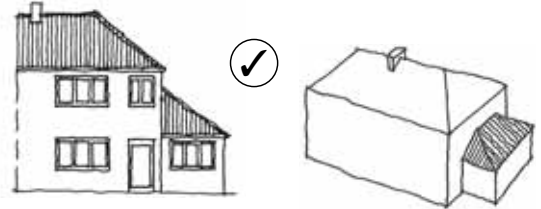

EX7 *Pitched roofs should be provided particularly in visually prominent locations.*

4.6 A pitched roof construction is preferable in design terms to flat roofs. "Dummy" pitches and parapets are generally discouraged as such designs are considered poor and can detract from the appearance of the property, particularly where the side elevation of the property is exposed in the street scene or the site is in a visually prominent location. However, these may be acceptable in individual circumstances. Refer figure 4 below.

Figure 4. Dummy pitch roof

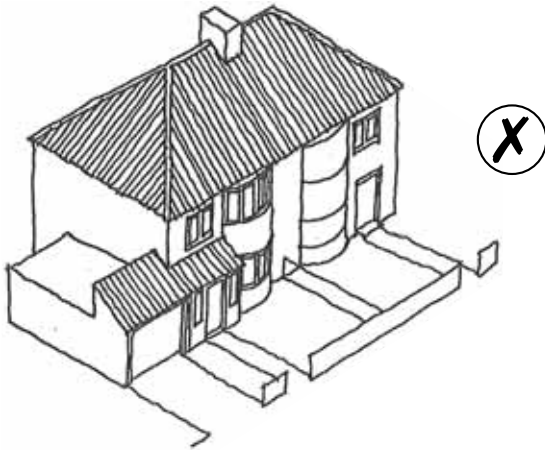

Side extension projecting forwards in front of house
Exposed dummy pitch roof

4.9 Under current Building Regulations there are restrictions on windows and openings in any wall adjoining a boundary for fire safety purposes.

EX10 *Proposals which result in the loss of on site parking will not generally be supported*

4.10 Unless adequate, alternative on site parking can be provided in accordance with the guidance for garages and parking.

EX8 *Single storey side extensions should not project forward of the front main wall of the property.*

4.7 Single storey side extensions should either be in line with the front main wall of the property or set back from the front main wall. Side extensions projecting forward of the front main wall of the existing house and "tying into" an adjoining single storey front extension will not be permitted as it is considered that this type of development dominates the front elevation of a property, detracting from the appearance of the dwelling and the character of the area.

EX9 *Flank wall windows will not normally be permitted.*

4.8 Windows should be positioned on the front and rear walls of the extension instead of the flank wall. Windows will not be supported in a flank wall where the wall of the extension abuts a side boundary. In cases where single storey side extensions are set off the boundary, and there is no alternative to providing flank wall windows, then these will need to be obscurely glazed and either non-opening or high level opening (minimum height at least 1.8 metres above the finished internal floor level) to prevent overlooking of neighbouring properties.

5.0 Two Storey/First Floor Side Extensions

5.1 As side extensions are often very visible from the street it is important to make sure these extensions do not detract from the original dwelling, or from the character of the area as a whole. Two storey/first floor side extensions due to their scale are often more contentious than single storey side extensions. Also as side extensions result in closure of the gap between dwellings, consideration needs to be given to the impact of such extensions on the amenities of adjoining property owners.

5.2 When assessing two storey/first floor side extensions the primary considerations will be the character of the locality, the space around the building and site considerations.

EX11 Two storey/first floor side extensions should be set off the side boundary by a minimum of 1 metre

5.3 In order to maintain a visual gap between buildings, thereby reducing the 'terracing' effect on the street scene, two storey/ first floor side extensions should be set off the side boundary by at least one metre. Ideally this should be at both ground and first floor levels in the interests of good design. Refer figures 5 and 6 below.

Figure 5. Example unacceptable visual terracing



Existing individual houses



Side extensions create visual terracing

Figure 6. Example maintenance of visual gap through 1m setback from boundary



Existing individual houses



Side extensions subordinate to original dwellings and set in from boundary by 1m

5.4 In cases where a two storey/first floor side extension exists and is built up to the boundary, planning applications for similar extensions on the neighbouring property will not normally be permitted unless a minimum two metre gap can be achieved at first floor level between the two extended properties.

5.5 However, in cases where it is proposed to construct a two storey/first floor side extension which is set off from the side boundary, but by doing so it would not be possible to provide a garage which complies with the minimum required internal standards of 5m x 2.5m it may, in such circumstances, be acceptable for the ground floor part of the side extension to be built up to the boundary. The first floor would still have to be set in off the side boundary by at least one metre. Furthermore, in cases where there is already a single storey side extension constructed up to the side boundary, the first floor extension would need to be set off the boundary by at least one metre.

5.6 It should be noted that a set in from the boundary at first floor level only may result in more complicated structural arrangements. Setting the entire extension back from the side boundary also has the advantage of giving room for maintenance and access to the rear garden without going through the house.

EX12 Two storey/first floor side extensions should be in proportion with and visually subordinate to the original house.

5.7 Two storey extensions should generally not exceed 50% of the width of the original dwelling in order to appear subordinate to the main dwelling. Although exceptions may be allowed where the character of the street allows.

Detached and semi-detached houses

5.8 There is usually more scope for extensions to detached and semi-detached houses than to terraced houses. However, a ‘terracing’ effect should be avoided, particularly where houses are of similar size and alignment.

EX13 For detached and semi-detached houses the minimum requirements are:

(a) A set back of the first floor front wall by at least 1 metre behind the main front wall.

(b) A subordinate pitched roof - two storey/ first floor side extensions should be set down below the ridge line of the main house by a minimum of 0.5 metre.

5.8 The set down in the roof combined with the set back at first floor level on the front elevation of the extension will ensure that the extension appears subordinate to the main house and helps to reduce the “terracing effect” on the general street scene. Refer to figure 7.

5.9 The requirement for a minimum 0.5 metre set down from the existing ridge will only be relaxed if it can be demonstrated that it is not feasible due to technical constraints

Figure 7. Minimum setbacks for two storey/first floor side extension

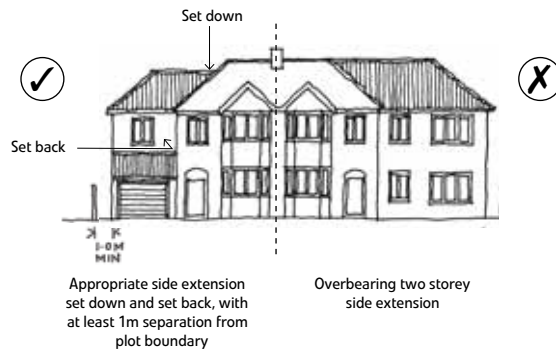

EX14 Roofs must respect the original roof form of the house. Flat roofs are not acceptable and parapet walls should be avoided.

5.10 Flat roofs are not normally acceptable for two storey/first floor extensions.

5.11 A pitched roof tied into the main roof of the house, set down and subordinate to it and which respects the pitch of the main roof and the eaves detail and profile is required.

5.12 The use of a parapet wall along the side elevation can be visually intrusive and therefore should be avoided, unless special site circumstances allow. Refer to figure 8.

Figure 8. Unacceptable side extension, including parapet wall

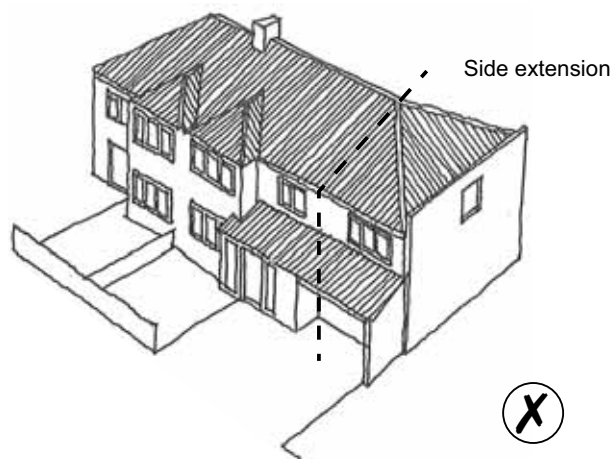

Side extension is not subordinate
No set down or set back from original dwelling
No set in from boundary
Parapet wall dominates side elevation
Window in side wall creates overlooking
Front extension runs into bay and is bulky

EX15 Two storey/first floor side extensions will not normally be permitted in Residential Areas of Exceptional Character

5.13 In Residential Areas of Exceptional Character, two storey/first floor side extensions will not normally be permitted in order to prevent terracing, maintain important spacing between existing buildings and to retain the character of the original building.

Terraced houses

5.14 In the case of end of terrace houses, first floor and two storey side extensions are normally acceptable without a set-back or subordinate roof, as a continuation of the established building form. General design considerations would apply. Refer figure 9 below.

Figure 9. Continuation extension to a terraced building form

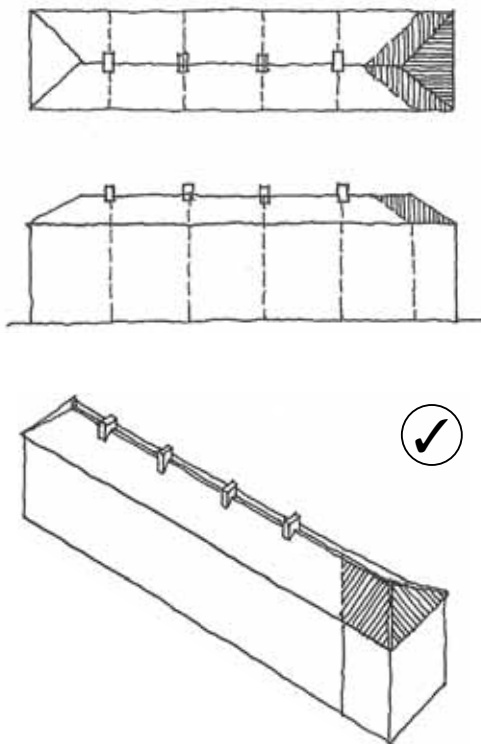

Acceptable side extensions as a continuation of terrace form

5.15 In densely built up housing estates the spaces between the rows of terraces can often provide an important visual break, giving relief in what is an otherwise densely built up area. These breaks are an important feature of the established character and street scene of these estates. In such cases, proposed first floor and two storey side extensions that occupy these spaces result in reductions in these important breaks. Particular care will be needed to avoid such extensions which would detract from the established pattern of development and result in the loss of these breaks.

Corner sites

5.16 On corner sites, because of their exposed nature, it is important that extensions reflect the pattern of development in the street scene. This is particularly so where the character around the corner plots is one of openness and space.

5.17 Consideration will be given to the established character of the street, any projection beyond existing building lines, the bulk and visual impact of the extension, and the relationship of the extension to side boundaries. Extensions should be subordinate to the original dwelling and be sited a minimum of one metre from corner boundaries at first floor level.

5.18 On prominent corner sites, two storey/first floor side extensions will not normally be accepted, especially where these breach the established building lines.

Sites with splayed boundaries

5.19 'Wedge shaped' first floor and two storey side extensions are unacceptable as these are out of character with the established pattern of development. There can also be problems of constructing the roof. As a general rule, two storey side and first floor side extensions should always be designed with walls that are parallel to the existing house walls. Refer figure 10 below.

Figure 10. Splayed extensions

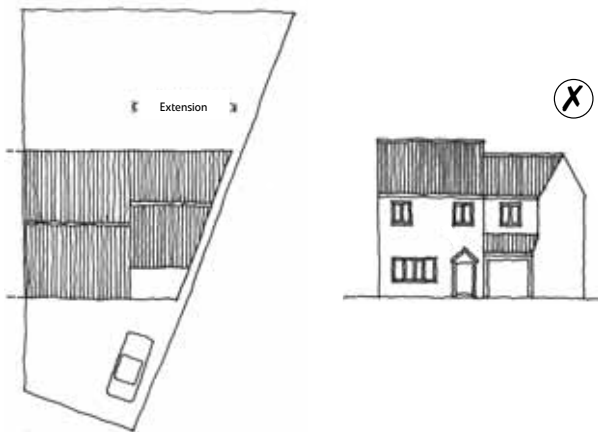

2 storey splayed side extension out of keeping with original dwelling

- 5.20 In cases where there is already a single storey side extension which follows the splayed boundary, it will still be expected that a first floor extension is designed with walls parallel to the existing house walls.
- 5.21 Two storey/first floor side extensions on sites with splayed boundaries also need to be appropriately sized to avoid these appearing visually intrusive in the street scene, overbearing for neighbours and resulting in visual 'terracing'. Consideration will need to be given to the established pattern of development and the openness of the street scene.
- 5.22 Extensions that are unduly complex or bulky will be unacceptable.

Existing extensions

- 5.23 Where the property has already been extended by the conversion of a hipped roof to a gable roof, a further side extension (first floor or two storey) is unlikely to be acceptable, for reasons of design, unbalancing in the case of a pair of semis, visual 'terracing' and/or loss of the visual gap.

Impact on neighbouring properties

- 5.24 Because side extensions result in closure of the gap between buildings, it is important to consider how the proposal might affect the amenity of the neighbouring property.

- 5.25 The side extension should not project significantly beyond the rear main wall of the neighbouring original dwelling.
- 5.26 Also try to ensure that the proposed extension will not adversely affect habitable rooms or any private amenity space through dominance or overlooking.
- 5.27 Side extensions should not significantly affect daylight/sunlight to neighbouring properties

EX16 *On neighbouring properties where there is an existing flank wall habitable room window(s) installed as part of the original house, and which is the only source or major source of light to the habitable room(s) it serves, the 45 degree vertical plane shall be maintained.*

- 5.28 The 45 degree plane will be measured from the bottom of the window (just above sill level) for the full width of the window. Compliance is required to ensure that adequate daylight is maintained to habitable rooms in neighbouring properties. Refer figure 11 below. A relaxation of the 45 degree rule (vertical axis) will only be permitted where it can be demonstrated that there would be no significant loss of daylight/sunlight by reference to the BRE sunlight/daylight indicators.

Figure 11. 45 degree vertical plane measured from sill level of protected side windows



No loss of light to neighbour's protected side window



Overpowering extension causing loss of light to neighbour's protected side window

EX17 Flank wall windows will not normally be permitted.

5.29 Windows in flank walls will generally be unacceptable as they result in overlooking and loss of privacy for neighbouring properties.

EX18 A minimum distance of 15 metres shall be maintained between a primary elevation of an existing house and the flank wall of a proposed two storey side extension.

5.30 To ensure that the proposed two storey side extension is not overbearing in its impact on the amenities of neighbouring residential occupiers. See figure 12 below.

EX19 Proposals which result in the loss of on site parking will not generally be supported.

5.31 Unless adequate, alternative on site parking can be provided in accordance with the guidance for garages and parking.

Two Storey Side to Rear Extensions

5.32 Where a two storey side extension would project rearward of the rear main wall of the adjacent property, the rear element will be considered as a two storey rear extension.

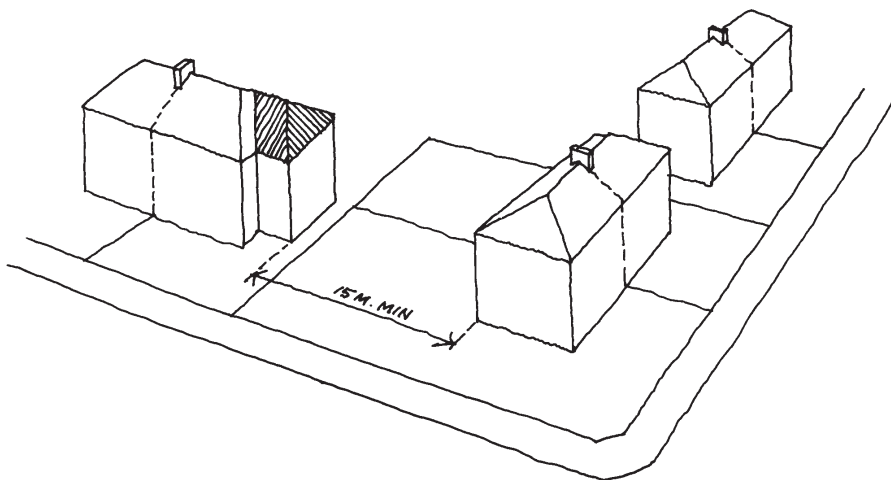
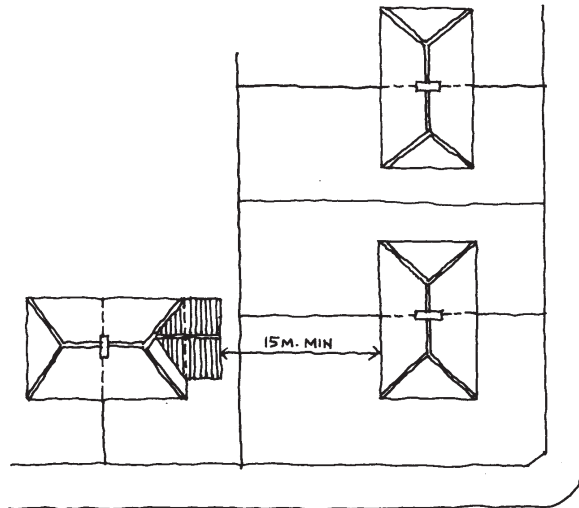

6.0 Single Storey Rear Extensions

6.1 Where single storey rear extensions require planning permission, the following guidance should be taken into account.

EX20 *The maximum permitted depth for a single storey rear extension is:*

- **3.65 metres for a terraced house**
- **4.25 metres for a semi-detached or detached house as measured from the rear main wall of the original house.**

6.2 Although in determining the maximum acceptable depth account will also be taken of:

- site considerations including any adjoining extensions, the rear building line (whether this is in line or staggered), any changes in ground level, whether the adjoining dwelling is sited away from the boundary; and
- the impact of the development on the amenity of neighbouring residents.

6.3 In the case of staggered building lines, the maximum permitted depth will be measured from the rear main wall (generally the two storey wall) of the affected neighbouring property in order to minimise impact on daylight and outlook and to maintain consistency between the properties. Refer figure 13 below.

Figure 13. Acceptable depth of single storey extensions where staggered building line exists

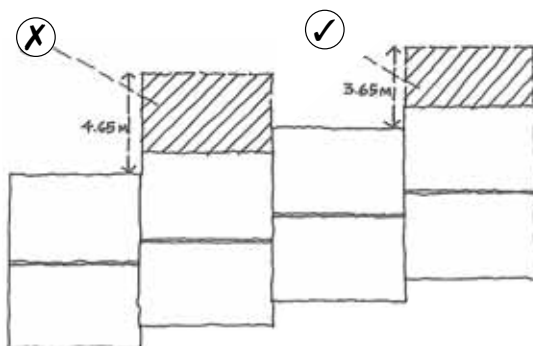

Acceptable depth of rear extensions where staggered building line exists. Acceptable depth is measured from rear main wall of neighbouring affected dwelling.

6.4 On corner plots, or where there is a corner plot which abuts the proposal site, with a very short garden(s), the acceptable depth may be less than the guideline as set, if it is adjudged that the proposed extension would have an overbearing or enclosing impact on the neighbouring property.

6.5 A relaxation of this guideline will only be considered in cases where there is adjudged to be no material impacts on the proposal house, any neighbouring properties or the general street scene.

6.6 Staggered building forms to achieve a greater depth are not acceptable in design terms. An even rear and flank building line is preferred in order to achieve a more uniform design.

EX21 *The maximum permitted height for a single storey rear extension abutting a residential boundary should generally be 3 metres for a flat roof and for a pitched roof 3 metres at the mid-point of the pitch at the side boundary, unless site circumstances dictate otherwise, e.g. on sloping sites.*

6.7 The height of single storey rear extensions should be minimised to restrict the impact on the amenities of neighbouring residents. In situations where the neighbour's ground level is lower than the proposal site, this will need to be taken into account when assessing the maximum height of the extension, to avoid an overbearing extension and excessive loss of light. Refer figure 14 below.

Figure 14. Acceptable depth of single storey extensions where staggered building line exists

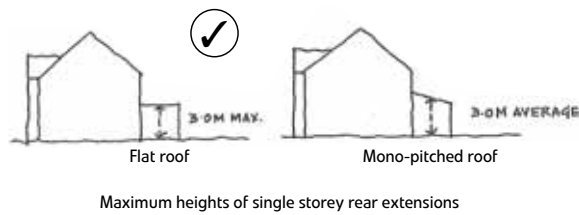

Maximum heights of single storey rear extensions

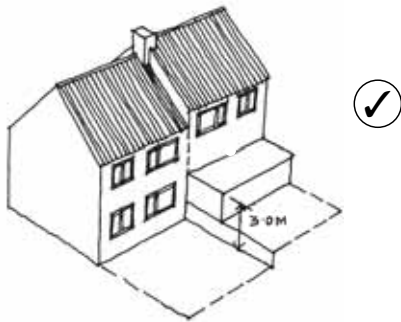

Maximum height of rear extensions where ground level varies between dwellings

EX22 Flank wall windows or doors will not normally be permitted unless it can be demonstrated that there is no impact on neighbouring privacy.

6.8 Windows should be positioned on the rear wall of the extension instead of the flank wall. Windows will not be supported in a flank wall where the wall of the extension abuts a side boundary. In cases where single storey rear extensions are set off the boundary, and there is no alternative to providing flank wall windows, then these will need to be obscurely glazed and either non-opening or high level opening (minimum height, at least 1.8 metres above the finished internal floor level) to prevent overlooking of neighbouring properties.

6.9 Rear conservatories which are proposed along a side boundary will need to be designed with brick or solid panel flank walls. Where these are set off the side boundary, glazing in the flank walls will only be permitted provided that a solid boundary wall or close boarded fence 1.8 metres high is maintained for at least the

depth of the rear conservatory. Again, windows above 1.8 metres will need to be obscurely glazed and non-opening to prevent overlooking of neighbouring properties.

6.10 Irregular shaped conservatories will be considered on their own merits.

6.11 Under current Building Regulations there are restrictions on windows and openings in any wall adjoining a boundary for fire safety purposes.

EX23 Balconies or terraces will not be permitted on flat roof single storey rear extensions.

6.12 In order to ensure that there is no overlooking or loss of privacy to neighbouring occupiers. Exceptions may apply with respect to large detached properties.

EX24 Pitched roofs should be at least 150mm below the level of any first floor window sill.

6.13 To ensure the design of the extension respects the original dwelling and the appearance of the dwelling is maintained.

EX25 "Secondary" or "additional" single storey rear extensions will only be permitted if the combined depth of both existing and proposed extensions does not exceed the maximum depths for single storey rear extensions.

6.14 The total depth of both extensions combined must not exceed the relevant maximum depth for single storey rear extensions. 'Leap-frogging', which would result in the Council's guidelines being exceeded, will not be permitted.

6.15 Please also refer to guidelines for Garden Space.

7.0 Two Storey/First Floor Rear Extensions

7.1 Rear extensions have the greatest potential for harm to the amenities of neighbouring residents. Two storey/first floor rear extensions due to their scale are more contentious than single storey rear extensions.

EX26 *Two storey and first floor rear extensions should be subordinate to the original dwelling and set back from boundaries shared with neighbouring properties to minimise potential impact on neighbours. Extensions will need to comply with the 45 degree code on the horizontal axis when measured from neighbouring properties*

7.2 Two storey or first floor rear extensions that abut a side boundary can significantly affect the amenity of neighbouring properties due to their large bulk and impact on light.

7.3 All such extensions will be required to comply with a 45 degree code. This is measured on the horizontal plane taken from the closest edge of the nearest first floor habitable window and is designed to ensure a reasonable outlook for neighbours and to maintain proportionality of extensions. Refer to figure 15 below. Extensions will also be assessed in terms of their proportionality with the original dwelling and impact on neighbouring residential amenities.

Figure 15. 45 degree horizontal plane measured from nearest two storey/first floor rear corner

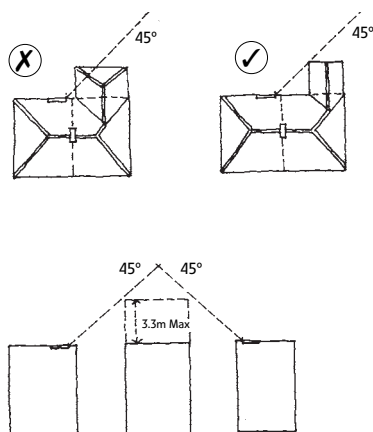

7.4 In assessing the impact on neighbours, consideration will also be given to other relevant site considerations, such as:

- The location of the adjacent house and any existing extensions or other buildings at that property
- The use of the adjacent rear garden
- The orientation of the houses - extensions sited to the south or west of a neighbour would normally be unacceptable.

7.5 In general, there is no potential for first floor or two storey rear extensions on mid terraced properties because of the adverse impact on adjacent properties and because such extensions are generally out of keeping with the pattern of development.

EX27 *The maximum permitted depth for a two storey rear extension will generally be 3.3 metres although deeper extensions may be allowed where site circumstances allow, such as detached dwellings on larger plots with good separation from neighbouring dwellings.*

7.6 To ensure that an extension is not too overbearing and to ensure that neighbours maintain a reasonable outlook from their property.

EX28 *Two storey and first floor rear extensions should respect the original form of the house.*

7.7 Staggered designs which respect the 45 degree horizontal plane will also be unacceptable as they result in poor designs and can have overly large and complicated roof forms which are undesirable.

EX29 *Roofs must respect the original roof form of the house. Flat roofs will not be acceptable.*

7.8 A pitched roof tied into the main roof of the house, set down and subordinate to it and which respects the pitch of the main roof and the eaves detail and profile is required.

A hipped roof rather than a gabled roof is preferred to reduce the bulk of the roof.

EX30 Flank wall windows will not normally be permitted.

7.9 Windows in flank walls will generally be unacceptable as they result in overlooking and loss of privacy for neighbouring properties. Refer figure 16 below.

Figure 16. Flank wall window overlooking neighbouring property



Flank window of extension overlooks neighbour's private space



No overlooking

EX31 Two storey/first floor side to rear extensions on corner plots must be subordinate to the main dwelling to avoid a detrimental impact on the general street scene and must not breach established building lines.

7.10 Two storey side to rear extensions on corner plots can be visually intrusive and harmful to the general street scene. Such extensions must not breach established building lines. As a minimum two storey rear extensions will need to be set in from the flank wall of the two storey side extension in order to provide a visual break in the flank wall of the extension and will need to have a hipped roof at the rear to minimise the visual bulk of the extension. Other site considerations will also need to be taken into account.

EX32 A minimum distance of 15 metres shall be maintained between the first floor rear wall of a two storey rear extension and the side boundary of an adjacent property.

7.11 To maintain a reasonable separation distance in order to avoid an unreasonable degree of overlooking of the neighbouring property, especially the primary amenity space.

7.12 Please also refer to guidelines for Garden Space.

8.0 Roof Extensions/Dormer Windows/Roof Lights

8.1 Where roof extensions require planning permission, the following guidance should be taken into account.

EX33 *Alterations to the main roof of the house by changing its shape and/or pitch or raising the ridge line will not normally be permitted.*

8.2 The roof form of a dwelling is an important part of the original character of the house. Alterations to roofs can be highly visible within the street scene and should be considered carefully. Any roof works which alter the existing side or top ridge lines should be avoided. Raising the main ridge will not be acceptable. Mansard roof extensions which change the slope of the roof will not usually be acceptable.

EX34 *Dormer windows will normally only be permitted on the rear of the building and should be in proportion with the size of the original roof. The following guidance shall apply:*

- *A minimum set down of 0.5 metre below the main ridge is generally required.*
- *A minimum set in distance of 1 metre at either end of the main roof slope on which it sits.*
- *The bottom of the dormer should be at least 1 metre above normal eaves level.*
- *A dormer must not occupy more than 50% of the width of the existing roof slope on which it sits. Refer to figure 17.*

Figure 17. Required set ins for rear dormer window extensions

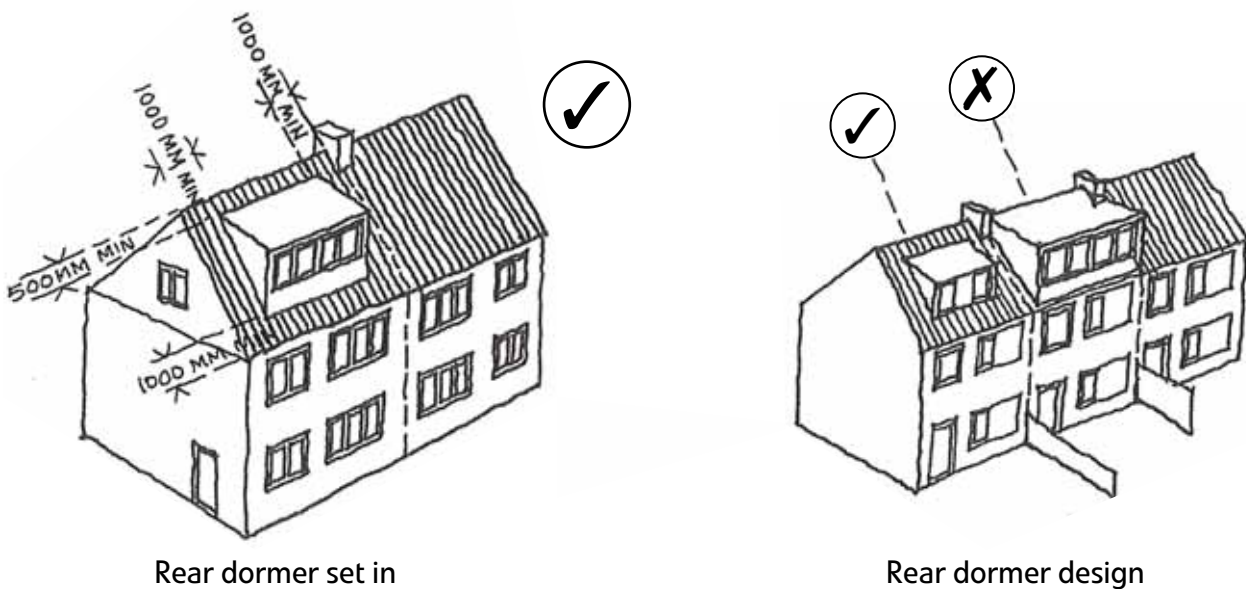

8.3 Dormer windows will normally only be permitted on the rear of the house where they are less visible from the street. However, they may not be permitted on properties with short gardens where there would be direct overlooking of neighbouring gardens.

8.4 These requirements could result in more complicated structural arrangements. Planning Officers will work closely with Building Control Officers to achieve a design which is acceptable both in visual and construction terms. Schemes will be considered on a case by case basis.

EX35 Side dormers will only be permitted where they are the only means available to provide stair access to the roof space and would not detract from the character of the original house or the general street scene. The criteria as set out for rear dormers will equally apply to side dormers.

8.5 Side dormers will only be allowed if well designed and where they do not compromise the street's character. Any application for a side dormer to provide access to the roof-space must provide accurate and scaled detailed drawings showing internal sections and staircases.

Overly large, angular and box like side dormers will not be permitted. Dormers which wrap around two roof slopes will be unacceptable. Refer figure 18 below.

8.6 Where side dormers are the only practical means of providing access to the roof space it may not always be possible to achieve a minimum 1 metre set off from eaves level and the necessary minimum headroom. In such circumstances Planning Officers will work closely with Building Control Officers to achieve the maximum degree of set off from eaves level possible. Each planning application will be assessed on a case by case basis.

EX36 Front dormers will generally be unacceptable.

8.7 Front dormers have the greatest potential for interfering with the original design of the house and are visually intrusive in the street scene. Only where these are characteristic of the street scene will they be considered.

EX37 Balconies will generally be unacceptable.

8.8 Balconies associated with roof extensions and dormer windows are not encouraged due to their visual impact and the potential for overlooking of neighbouring properties.

Figure 18. Wrap around dormer extensions unacceptable

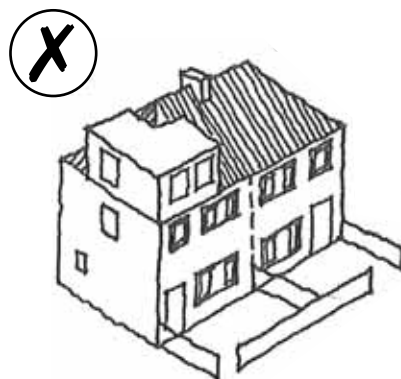

Rear dormers should not wrap around roof slopes

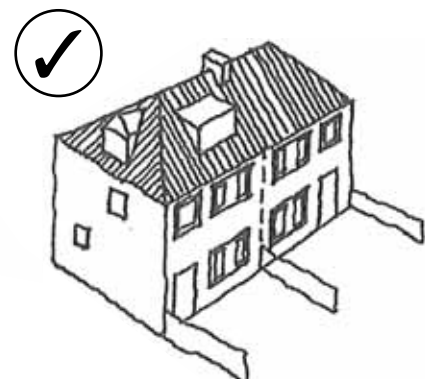

Appropriate scale and positioning of rear dormers

9.0 Outbuildings

- 9.1 Where outbuildings require planning permission, the following guidance should be taken into account.
- EX38** *Outbuildings should not detract from the character of the area through over dominance or obtrusiveness.*
- 9.2 Outbuildings in front of dwellings will be generally unacceptable. This is because outbuildings in front gardens tend to be unduly prominent and out of keeping with the character of the area.
- 9.3 As such outbuildings, depending on their function, should normally be located toward the rear of the rear garden. Exceptions may be made for garages to the side of the house.
- EX39** *The acceptable scale/ size of outbuildings (including footprint and height) will be determined having regard to:*
- *Size of the original dwelling*
 - *Garden plot/ sizes*
 - *Siting of the outbuilding within the site relative to boundaries*
 - *Siting of the outbuilding relative to public highway*
 - *Changes in levels between properties*
 - *Existing features, such as outbuildings, fences, walls, trees*
 - *Pattern of development in area*
 - *Orientation of properties*
- 9.4 Outbuildings should not exceed the footprint of the original dwelling and should always be subordinate to the main dwelling.
- 9.5 Outbuildings should not exceed a maximum height of 3 metres above ground level in the case of an outbuilding with a flat roof and 4 metres in the case of an outbuilding with a dual pitched roof. Although, in situations where the neighbour's ground level is lower than the proposal site this will need to be taken into account when assessing the maximum height of the outbuilding to avoid an overbearing impact and excessive loss of light.
- 9.6 Outbuildings should be single storey, limited to a single floor only.
- 9.7 Any development should ensure that the required depth/area of rear garden is achieved, unless the established character of the locality indicates otherwise. Refer to the guidelines for Garden Space (Refer to Section 11.0).
- 9.8 Outbuildings, where these would be visible from the adjacent public highway may need to be reduced in height and size to ensure these do not have a detrimental impact on the street scene, especially in the case of prominent corner sites.
- 9.9 Depending on the impacts of the development on a neighbouring property, conditions may be imposed on outbuilding proposals in terms of external materials/ finishes, landscaping, windows.
- 9.10 The design of the outbuilding should reflect their intended use.
- 9.11 Outbuildings shall not be used as a separate independent dwelling unit as this raises issues of privacy, overlooking, noise and disturbance for neighbours, parking, and amenity space and would generally be contrary to the pattern of development.
- 9.12 In the case of a proposal for a 'Granny Flat', Policy H18 of the Local Plan requires that the accommodation is provided in the form of an extension to the existing dwelling and not as a free standing independent structure. Further, that such extensions will not be allowed to have an independent external access to ensure that when these extensions are no longer required for the elderly relative, they can be incorporated into the main dwelling without the possibility of these being used as a separate independent dwelling unit. Refer to the full wording of the policy in Appendix 1 of these guidelines.

10.0 Garages, Parking and Hard Surfacing

EX40 *Proposals for extensions involving an increase in the number of bedrooms, which result in a net loss of car parking on site will not be permitted unless the level of retained or re-provided car parking on site complies with the Council's parking guidelines.*

Replacement car parking should comply with the additional guidelines provided below.

10.1 The following on site car parking guidelines apply:

- 2 car parking spaces for a 2/3 bedroom house.
- 3 car parking spaces for a 4 + bedroom house.

10.2 The Planning Authority may consider a relaxation of the parking standard for a 4 bedroom house down to 2 on site parking spaces where it can be demonstrated that either there is sufficient capacity within the street to accommodate the shortfall without causing congestion or road safety problems, or that the site has good access to public transport services.

EX41 *Garages should have a minimum internal width of 2.5 metres and an internal depth of 5 metres.*

10.3 Garages should have a minimum internal width of 2.5 metres and an internal depth of 5 metres to allow sufficient space to get in and out. Driveways should have a depth of at least 6 metres, to allow sufficient space for opening of the garage door and parking on the drive clear of the footpath and/or carriageway. This can be reduced to 5 metres in cases where suitably designed roller shutter garage doors are used.

EX42 *External parking should have a minimum width of 2.4 metres and a minimum depth of 4.8metres.*

10.4 In proposed parking layouts, each external parking space must achieve minimum dimensions of 2.4 metres width by 4.8 metres depth. Where extensions are

proposed, a minimum distance of 5 metres must be maintained between the back edge of footpath and the forward most part of any extension/building to allow vehicles to be parked without overhanging the footpath and/or carriageway. Parking layouts should also show a 1 metre clear access for pedestrians to the main entry of the dwelling.

EX43 *The design and siting of a garage should not detract from the appearance of the original house or general street scene.*

10.5 A new garage can have as much impact on the visual appearance of the house as any other extension. Wherever possible garages should form traditional shapes, such as a lean-to extension at the side of the house, or incorporated into two storey side extensions. Garages should not breach the front building line of the original house. The principles set out for side extensions should be taken into account as guidance relating to proportionality and spacing off the boundary. Prefabricated garages are not recommended where they will be visible from the street. Roller shutter garage doors will only be permissible if of an acceptable design.

10.6 A double garage at the side of the house will not normally be permitted as it can unbalance the main house. Double garages are larger and more bulky and are generally discouraged. They may be acceptable within the rear garden where they are less visible from the street provided they do not significantly harm the amenities of neighbours.

EX44 *Cars leaving a property should have good pedestrian visibility. Vehicle entry gates should not open out onto the public highway.*

10.7 Pedestrian visibility splays of 2.4 metres x 2.4 metres measured either side of the driveway entrance taken from the back edge of the footpath shall be provided and

no obstructions (front wall, gates, landscaping) shall be erected within these areas which would exceed a height of 600 mm above the adjacent carriageway level. Vehicle entry gates shall open into the property to avoid conflicts with pedestrian/highway movements. Refer figure 19 below.

Figure 19. Pedestrian visibility splays either side of a driveway entrance

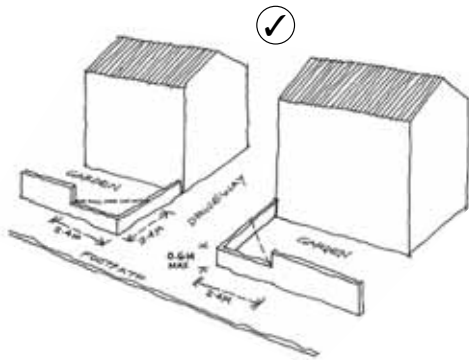

EX45 Continuous vehicle crossovers will not be permitted.

10.8 Crossovers extending the entire width across a property will not be permitted as they reduce on-street parking and result in pedestrian/vehicular conflict. Normally, only single width vehicular crossovers will be permitted. There is also a fundamental street scene issue of a large area of hard standing. Low front boundary walls in keeping with the street scene will be required to restrict the area of the property frontage over which vehicles can cross. Details of which will need to be submitted as part of parking layout schemes. Further guidance on vehicle crossovers can be obtained from the Highway Authority.

EX46 New areas of hard surfacing or replacement of existing areas of hard surfacing between the principal elevation of the dwelling house and the highway or anywhere else within the curtilage of a dwelling house if the area would exceed 5 square metres now may be subject to the need for planning permission.

10.9 The new permitted development provisions for development within the curtilage of a dwelling house state that planning permission will now be required if the hard

surface is not made of porous materials, or no provision is made to direct the run-off from the hard surface to a permeable or porous area of surface within the curtilage of the dwelling house. Further guidance on this matter can be found in the Environment Agency publication "Guidance on the permeable surfacing of front gardens", Sept 2008 and by reference to the Planning Portal web link

<http://www.planningportal.gov.uk/england/genpub/en/1115316438482.html> "What is the problem paving over front gardens".

10.10 No surface water (usually rainwater) should flow from the hard standing onto the public footway outside a house. In order to achieve this, hard standing areas will need to be sloped away from the public footway to a suitably designed drain or soak away within the property to receive the surface water. Also in certain circumstances applicants may need to ensure that they are breach existing requirements under the building regulations about water penetration into any building or affecting any existing disabled access ramps or level thresholds.

EX47 Front garden areas and front boundary treatment shall be laid out to respect the pattern of development in the street.

10.11 To avoid the cumulative effects of continuous, hard landscaped, open frontages, being created to the detriment of the general street scene, parking layout designs shall achieve a balance of hard and soft landscaping to reflect as much as possible the pattern of development in the street, together with suitable boundary treatment. Please also note that gates, fences, walls and other means of enclosure erected or constructed adjacent to a highway used by vehicular traffic must not exceed one metre above ground level. Otherwise planning permission would be required. Front boundary treatment also needs to comply with pedestrian visibility splays (refer above). Where planning permission is required, such schemes will need to be agreed with the Local Planning Authority.

11.0 Garden Space/Boundary Walls

EX48 *Rear extensions shall not be permitted unless the usable retained rear garden area complies with the following minimum guidelines:*

- *One bedroom houses, a minimum garden depth of 7 metres. Where 7 metres cannot be achieved because of irregular boundaries, a relaxation of this standard may be allowed provided the garden size exceeds 40 square metres.*
- *Two/three bedroom houses, a minimum garden depth of 9 metres (or 50 square metres, as above)*
- *Four bedroom + houses, a minimum garden depth of 15 metres (or 100 square metres, as above)*

11.1 These guidelines relate to open usable garden areas and exclude any large sheds or stores which occupy the retained garden area. Such structures should be clearly indicated on submitted plans.

11.2 In cases where rear extensions are permitted, but the retained garden area is at or just marginally above the guidelines as set out above, planning conditions will be imposed which remove permitted development rights on the property. This will give the Council a degree of control over the scale, size, appearance and siting of any structures or buildings which an owner/occupier may wish to construct in the rear garden at some future date.

11.3 Gardens are an enjoyable feature of most houses and retention of a reasonable level of amenity space will help to ensure that plots do not become overdeveloped to the detriment of adjoining neighbours and the surrounding locality. The garden area will be assessed on its usability and quality.

11.4 The minimum garden depths as set out above will allow the construction of soakaways for the correct disposal of surface water from approved extensions, which need to be located at least 5 metres from the completed extension.

EX49 *Walls/gates/fences/other means of enclosure shall be designed to reflect the existing character of the street and surrounding area*

11.5 Under permitted development rights, any gate, fence, wall or other means of enclosure constructed or erected adjacent to a highway used by vehicular traffic must not exceed 1 metre in height. This includes situations where the end of the structure or means of enclosure abuts the highway (i.e. is perpendicular to the highway).

11.6 Any other gate, fence, wall or other means of enclosure must not exceed 2 metres in height. Otherwise planning permission will be required.

11.7 The same height restrictions apply for any alterations or improvements made to any existing gate, fence, wall or other means of enclosure.

11.8 No permitted development rights apply in the case of gates, fences, walls or other means of enclosure surrounding a listed building.

11.9 Where planning permission is required for front boundary walls/fences/gates/other means of enclosure, those which do not reflect the character of the area, for example introducing automatic gates, railings, should be avoided. Refer figure 20 below.

Figure 20. Boundary treatment must reflect character of area

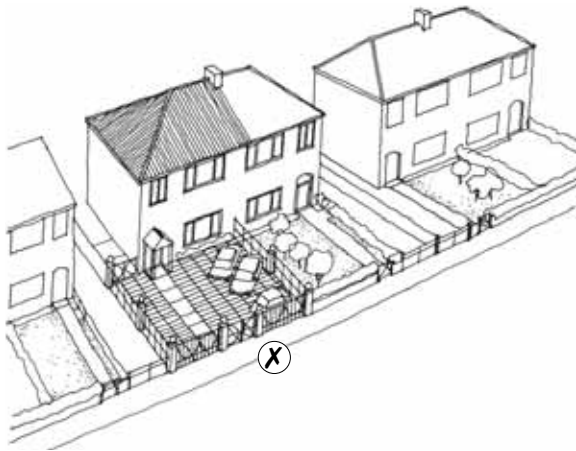

Garden wall/fence over height relative to others in the street scene and using incompatible materials

EX50 *Cars leaving a property should have good pedestrian visibility. Vehicle entry gates should not open out onto the public highway.*

11.10 Pedestrian visibility splays of 2.4 m x 2.4 m measured either side of the driveway entrance taken from the back edge of the footpath shall be provided and no obstructions (front wall, gates, landscaping) shall be erected within these areas which would exceed a height of 600mm above the adjacent carriageway level. Vehicle entry gates shall open into the property to avoid conflicts with pedestrian/highway movements. Refer figure 18 above.

Appendix 1 - Policies in the Slough Core Strategy 2006-2026

Core Policy 1 (Spatial Strategy)

All development will have to comply with the Spatial Strategy set out in this document.

All development will take within the built up area, predominantly on previously developed land, unless there are very special circumstances that would justify the use of Green Belt land. A strategic gap will be maintained between Slough and Greater London.

Proposals for high density housing, intensive employment generating uses, such as B1(a) offices, and intensive trip generating uses, such as major retail or leisure uses, will be located in the appropriate parts of Slough town centre. Such development will have to be comprehensively planned in order to deliver maximum social, environmental and economic benefits to the wider community.

Proposals for the comprehensive regeneration of Selected Key Locations within the Borough will also be encouraged at an appropriate scale. Some relaxation of the policies or standards in the Local Development Framework may be allowed where this can be justified by the overall environmental, social and economic benefits that will be provided to the wider community.

Elsewhere the scale and density of development will be related to the site's current or proposed accessibility, character and surroundings. Significant intensification of use will not be allowed in locations that lack the necessary supporting infrastructure, facilities or services or where access by sustainable means of travel by public transport, cycling and walking are limited.

Core Policy 2 (Green Belt And Open Spaces)

The existing areas of Metropolitan Green Belt will be maintained and Wexham Park Hospital and Slough Sewage Works will continue to be designated as Major Existing Developed Sites within the Green Belt.

Opportunities will be taken to enhance the quality and the size of the Green Belt by designating additional areas, which have no development potential, as Green Belt.

Development will only be permitted in the Strategic Gap between Slough and Greater London and the open areas of the Colne Valley Park if it is essential to be in that location.

Existing private and public open spaces will be preserved and enhanced. Where, exceptionally, it is agreed that an open space may be lost a new one, or suitable compensatory provision, will be required to be provided elsewhere.

Core Policy 3 (Housing Distribution)

A minimum of 6,250 new dwellings will be provided in Slough between 2006 and 2026.

This will be distributed as follows:

- Town Centre
a minimum of 3,000 dwellings
- Urban Extensions
around 750 dwellings
- Major sites in other Urban Areas
around 1,350 dwellings
- Small sites within the Urban Area
around 600 dwellings

Any additional housing required as a result of an increase in Slough's allocation in the South East Plan will be built in the town centre or in other appropriate urban areas in accordance with the Spatial Strategy.

New development should not result in the net loss of any existing housing.

Core Policy 4 (Type Of Housing)

High-density housing should be located in Slough town centre.

In the urban areas outside the town centre, new residential development will predominantly consist of family housing and be at a density related to the character of the surrounding area, the accessibility of the location, and the availability of existing and proposed local services, facilities and infrastructure.

Within existing suburban residential areas there will only be limited infilling which will consist of family houses that are designed to enhance the distinctive suburban character and identity of the area.

All new residential development will be constructed at a minimum net density of 37 dwellings per hectare. Densities less than this may be permitted on small sites, where the character is low density or where there are other site constraints.

There will be no net loss of family accommodation as a result of flat conversions, changes of use or redevelopment.

All sites of 15 or more dwellings (gross) will be required to provide between 30% and 40% of the dwellings as social rented along with other forms of affordable housing.

Proposals for gypsy or traveller sites will not generally be permitted in the urban area. If there is a proven need for a gypsy or traveller site or sites in Slough, this could be considered to constitute exceptional circumstances that would justify the relaxation of Green Belt policy.

Core Policy 5 (Employment)

The location, scale and intensity of new employment development must reinforce the Spatial Strategy and transport strategy. This includes the application of a parking cap upon new developments unless additional parking is required for local road safety or operational reasons.

Intensive employment generating uses such as B1(a) offices will be located in the town centre in accordance with the spatial strategy.

B1(a) offices may also be located on the Slough Trading Estate, as an exception, in order to facilitate the comprehensive regeneration of the estate. This will be subject to the production of a Masterplan and the provision of a package of public transport improvements. This will be partly delivered through a subsequent Local Development Order which will replace the Simplified Planning Zone brought forward in accordance with the provisions in Circular 01/2006 (DCLG).

Intensive employment-generating uses which increase the level of in-commuting, increase skill shortages or reduce employment opportunities for local people will be expected to contribute toward appropriate mitigation measures, including new training, childcare and transport facilities.

Major warehousing and distribution developments will be located in the eastern part of the Borough and in Existing Business Areas that have good access to the strategic road and rail network.

There will be no loss of the defined Existing Business Areas to non-employment generating uses, especially where this would reduce the range of jobs available. Outside Existing Business Areas, the change of use or redevelopment of existing offices to residential will be encouraged where this is considered appropriate.

Core Policy 6 (Retail, Leisure And Community Facilities)

All new major retail, leisure and community developments will be located in the shopping area of the Slough town centre in order to improve the town's image and to assist in enhancing its attractiveness as a Primary - Regional Shopping Centre.

Out-of-centre and edge-of-centre retail developments will be subject to the sequential test. Developers will be required to demonstrate that:

- a. There is a need for the development;
- b. It is of an appropriate scale;
- c. There are no sequentially preferable sites in designated centres;
- d. The development would not have a detrimental impact on the vitality and viability of existing centres; and
- e. The site is accessible by a variety of a means of transport.

All community facilities/services should be retained. Where, exceptionally, it is agreed that community facilities/services may be lost or reduced in size to accommodate new development, developers will be required to contribute towards new or enhanced community facilities/services locally.

Core Policy 7 (Transport)

All new development should reinforce the principles of the transport strategy as set out in the Council’s Local Transport Plan and Spatial Strategy, which seek to ensure that new development is sustainable and is located in the most accessible locations, thereby reducing the need to travel.

Development proposals will, either individually or collectively, have to make appropriate provisions for:

- f. Reducing the need to travel;
- g. Widening travel choices and making travel by sustainable means of transport more attractive than the private car;
- h. Improving road safety; and
- i. Improving air quality and reducing the impact of travel upon the environment, in particular climate change.

Development proposals will also have make contributions to, or provision for:

- j. The development of Slough town centre as a Regional Transport Hub;
- k. The improvement of key transport corridors such as the links to Heathrow Airport;
- l. Improvements to Slough, Burnham and Langley railway stations; and
- m. The creation of a transport hub within Slough Trading Estate.

There will be no overall increase in the number of parking spaces permitted within commercial redevelopment schemes unless this is required for local road safety or operational reasons. Maximum restraint will be applied to parking for residential schemes in the town centre. In the rest of the Borough, the level of parking within residential development will be appropriate to both its location and the scale of the development and taking account of local parking conditions, the impact upon the street scene and the need to overcome road safety problems and protect the amenities of adjoining residents.

Core Policy 8 (Sustainability And The Environment)

All development in the Borough shall be sustainable, of a high quality design, improve the quality of the environment and address the impact of climate change.

1. Sustainable Design and Construction Principles:

All development should, include measures to:

- a) Minimise the consumption and unnecessary use of energy, particularly from non renewable sources;
- b) Recycle waste;
- c) Generate energy from renewable resources where feasible
- d) Reduce water consumption; and
- e) Incorporate sustainable design and construction techniques, including the use of recycled and energy efficient building materials.

2. High Quality Design:

All development will:

- a) Be of a high quality design that is practical, attractive, safe, accessible and adaptable;
- b) Respect its location and surroundings;
- c) Provide appropriate public space, amenity space and landscaping as an integral part of the design; and
- d) Be in accordance with the Spatial Strategy in terms of its height, scale, massing and architectural style.

The design of all development within the existing residential areas should respect the amenities of adjoining occupiers and reflect the street scene and the local distinctiveness of the area.

3. Pollution

Development shall not:

- a) Give rise to unacceptable levels of pollution including air pollution, dust, odour, artificial lighting or noise;

- b) Cause contamination or a deterioration in land, soil or water quality; and
- c) Be located on polluted land, areas affected by air pollution or in noisy environments unless the development incorporates appropriate mitigation measures to limit the adverse effects on occupiers and other appropriate receptors.

4. Flooding

- a) Development will only be permitted where it is safe and it can be demonstrated that there is minimal risk of flooding to the property and will not impede the flow of floodwaters, increase the risk of flooding elsewhere or reduce the capacity of a floodplain; and
- b) Development must manage surface water arising from the site in a sustainable manner which will also reduce the risk of flooding and improve water quality.

Core Policy 9 (Natural And Built Environment)

Development will not be permitted unless it:

- n. Enhances and protects the historic environment;
- o. Respects the character and distinctiveness of existing buildings, townscapes and landscapes and their local designations;
- p. Protects and enhances the water environment and its margins;
- q. Enhances and preserves natural habitats and the bio-diversity of the Borough, including corridors between bio- diversity rich features.

Core Policy 10 (Infrastructure)

Development will only be allowed where there is sufficient existing, planned or committed infrastructure. All new infrastructure must be sustainable.

Where existing infrastructure is insufficient to serve the needs of new development, the developer will be required to supply all reasonable and necessary on-site and off-site infrastructure improvements. These improvements must be completed prior to the occupation of a new development and should serve both individual and communal needs.

Infrastructure includes:

- r. Utilities (water, sewerage and drainage);
- s. Transportation;
- t. Education and skills;
- u. Health;
- v. Leisure, community and cultural services; and
- w. Other relevant services.

The provision of reasonable and necessary infrastructure will be secured through planning obligations or by conditions attached to planning permissions.

Core Policy 11 (Social Cohesiveness)

The development of new facilities which serve the recognised diverse needs of local communities will be encouraged. All development should be easily accessible to all and everyone should have the same opportunities.

Core Policy 12 (Community Safety)

All new development should be laid out and designed to create safe and attractive environments in accordance with the recognised best practice for designing out crime. Activities which have the potential to create anti-social behaviour will be managed in order to reduce the risk of such behaviour and the impact upon the wider community.

Appendix 1 - Relevant Saved Policies of the Slough Local Plan (2004)

Policy H14 (Amenity Space)

The appropriate level will be determined through consideration of the following criteria:

- a) type and size of dwelling and type of household likely to occupy dwelling;
- b) quality of proposed amenity space in terms of area, depth, orientation, privacy, attractiveness, usefulness and accessibility;
- c) character of surrounding area in terms of size and type of amenity space for existing dwellings;
- d) proximity to existing public open space and play facilities; and
- e) provision and size of balconies.

Policy H15 (Residential Extensions)

Proposals for extensions to existing dwelling houses will only be permitted if all of the following criteria are met:

- a) there is no significant adverse impact on the amenity of adjoining occupiers;
- b) they are of a high quality of design and use materials which are in keeping with both the existing property and the identifiable character of the surrounding area;
- c) they respect existing building lines and there is no significant adverse impact on the existing street scene or other public vantage points;
- d) appropriate parking arrangements are provided in line with the aims of the integrated transport strategy;
- e) an appropriate level of rear garden amenity space is maintained.

In exceptional circumstances, a relaxation of normal standards may be allowed to meet any special medical needs of family members.

Policy H18 (Granny Annexes)

Proposals for the extension of residential properties to provide accommodation for elderly relatives/dependants will not be permitted unless they comply with all the following criteria:

- a) the accommodation is provided in the form of an extension to the existing dwelling and not as a free standing independent structure;
- b) the accommodation is designed as an integral part of the house and is capable of being used in the future as part of the original dwelling unit and therefore has no independent external access;
- c) the accommodation is only to be occupied by an elderly relative or dependant and will not be used as a separate independent dwelling unit at any time;
- d) the appearance, design and bulk of the proposed extension is appropriate for its location and does not have an unacceptable impact upon the amenities of the area;
- e) provision is made for an appropriate amount of car parking which meets the aims of the integrated transport strategy; and
- f) appropriate rear private amenity space is retained.

Policy En1 (Standard Of Design)

Development proposals are required to reflect a high standard of design and must be compatible with and/or improve their surroundings in terms of:

- a) scale;
- b) height;
- c) massing/Bulk;
- d) layout;
- e) siting;
- f) building form and design;
- g) architectural style;
- h) materials;
- i) access points and servicing;
- j) visual impact;
- k) relationship to nearby properties;

- l) relationship to mature trees; and
- m) relationship to water courses.

These factors will be assessed in the context of each site and their immediate surroundings. Poor designs which are not in keeping with their surroundings and schemes which result in over-development of a site will be refused.

Policy En2 (Extensions)

Proposals for extensions to existing buildings should be compatible with the scale, materials, form, design, fenestration, architectural style, layout and proportions of the original structure. Extensions should not result in the significant loss of sunlight or create significant overshadowing as a result of their construction.

Policy T2 (Parking Restraint)

Within all developments that attract an increase in the number of trips, the level of on-site parking provision for the private car will be restricted to a maximum level in accordance with the principles of the Integrated Transport Strategy.

No increase in the total number of car parking spaces on-site will be permitted within commercial redevelopment schemes.

Additional on-site car parking provision will only be required where this is needed to overcome road safety problems, protect the amenities and operational requirements of adjoining users, and ensure that access can be obtained for deliveries and emergency vehicles.

Residential development will be required to provide a level of parking appropriate to its location and which will overcome road safety problems, protect the amenities of adjoining residents, and not result in an adverse visual impact upon the environment.

Useful telephone numbers

General Planning Enquiries

- 01753 477340
- 01753 875806

General Building Control Enquiries

- 01753 875810

General Highway Enquiries

- 01753 875668
- 01753 477378

General Drainage Enquiries

- 01753 875625

Thames Water General Enquiries

- 0845 9200800

Environment Agency

- 08708 506506

This document can be made available on audio tape, braille or in large print, and is also available on the website where it can easily be viewed in large print.

If you would like a copy of this document translated please ask an English speaking person to request this by calling 01753 875820. Alternatively please call Slough Translation and Interpreting Service on 01753 701159.

यदि आप इस दस्तावेज़ के अनुवाद की कापी हासिल करनी चाहते हैं तो कृपया अंग्रेज़ी बोलने वाले किसी व्यक्ति को कहें कि वोह 01753 875820 पर टैलीफोन करके निवेदन करे। या 01753 701159 पर सलोह ट्रांसलेशन एण्ड इन्टरप्रेटेशन सर्विस को टैलीफोन करे।

Aby otrzymać kopię tego dokumentu przetłumaczoną na język polski należy poprosić osobę mówiącą po angielsku o zadzwonienie z takim żądaniem pod numer 01753 875820. Można również skontaktować się z serwisem tłumaczy 'Translation and Interpreting' w Slough, telefon 01753 701159.

ਜੇ ਤੁਸੀਂ ਇਸ ਦਸਤਾਵੇਜ਼ ਦੇ ਤਰਜਮੇ ਦੀ ਕਾਪੀ ਲੈਣੀ ਚਾਹੁੰਦੇ ਹੋ ਤਾਂ ਕਿਰਪਾ ਕਰਕੇ ਅੰਗ੍ਰੇਜ਼ੀ ਬੋਲਣ ਵਾਲੇ ਕਿਸੇ ਵਿਅਕਤੀ ਨੂੰ ਕਹੋ ਕਿ ਉਹ 01753 875820 ਤੇ ਟੈਲੀਫੋਨ ਕਰਕੇ ਬੇਨਤੀ ਕਰੇ। ਜਾਂ 01753 701159 ਤੇ ਸਲੋਹ ਟਰਾਂਸਲੇਸ਼ਨ ਅਤੇ ਇੰਟਰਪ੍ਰੇਟੇਸ਼ਨ ਸਰਵਿਸ ਨੂੰ ਟੈਲੀਫੋਨ ਕਰੋ।

Haddii aad doonaysid koobi dokumentigan ah oo turjuman fadlan weydiiso qof Ingiriisiga ku hadla si aad u codsatid adigoo soo wacaya 01753 875820. Haddii kalese fadlan kasoo wac Slough Translation and Interpreting Service 01753 701159

اگر آپ کو اس ڈاکیومنٹ (دستاویز) کی ترجمہ شدہ کاپی درکار ہو تو، براہ کرم انگریزی بولنے والے کسی شخص سے کہیں کہ وہ 01753 875820 پر فون کر کے طلب کرے۔ یا 01753 701159 پر سلاؤ ٹرانسلیشن اینڈ انٹراپریٹنگ سروس کو فون کریں۔